

The Mysterious Polar Magnetic Fields and Their Use for Solar Sunspot Cycle Predictions

Leif Svalgaard

Stanford University, California, USA

Polar Perspectives Workshop, Boulder, CO,
Sept. 25, 2018



Earliest Measurements of 'Polar Fields'

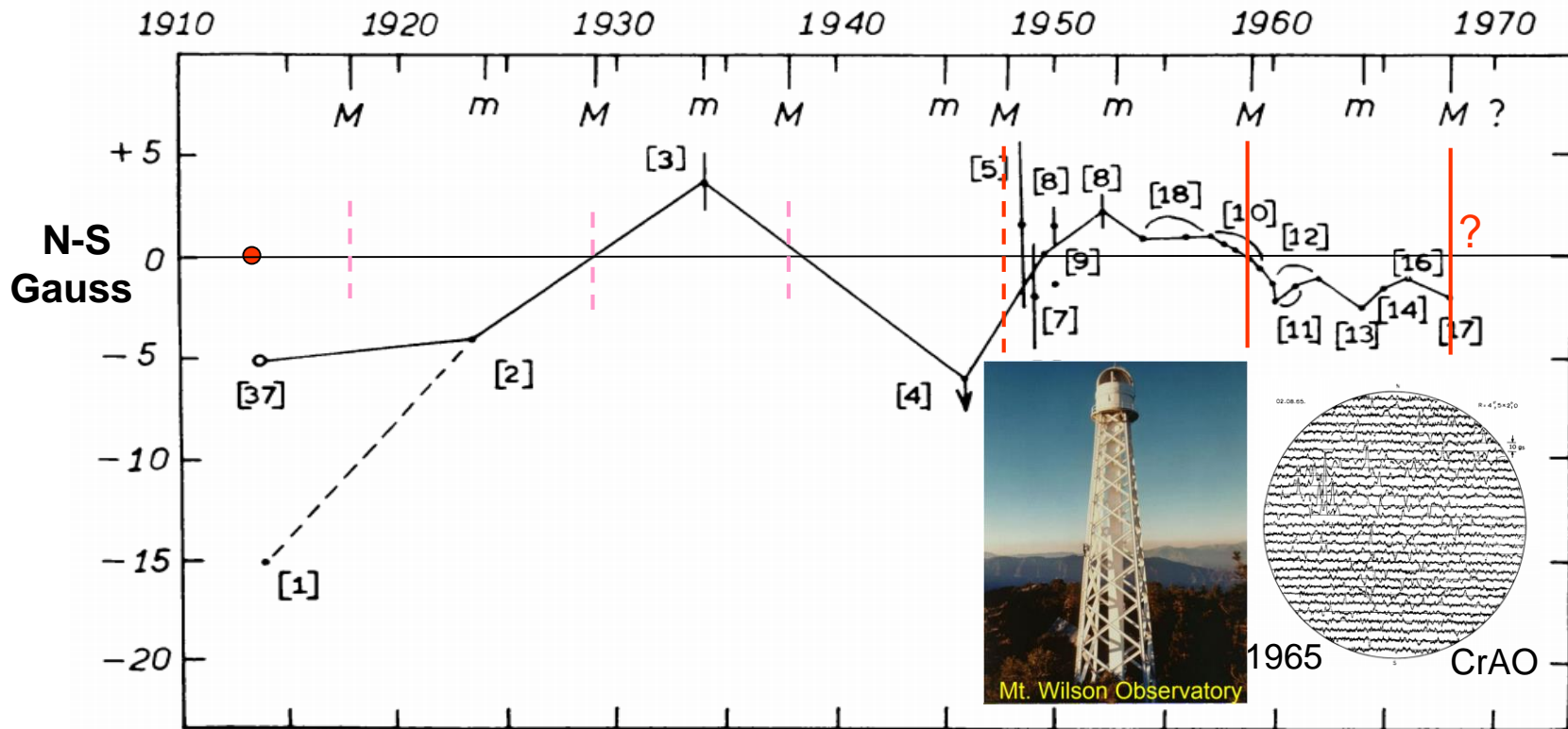

Fig. 1. Representing on a graph the separate determinations of the polarity and magnitude of the general magnetic field of the Sun. [1] = Hale *et al.*, 1918; [2] = Langez, 1936; [3] = Adams, 1934; [4] = Babcock, 1948; [5] = Thiessen, 1946, 1952; [6] = Adams, 1949; [7] = Von Klüber, 1951; [8] = Babcock and Cowling, 1953; [9] = Kiepenheuer, 1953; [10] = Babcock, 1959; [11] = Howard, 1965; [12] = Von Klüber, 1965; [13] = Severny, 1966; [14] = Severny, 1967; [16] = Stenflo, 1968; [17] = Stenflo, 1968; [18] = Babcock and Babcock, 1955; [37] = Stenflo, 1970*. → ●

A.B. Severny, The Polar Fields, etc [Howard, ed. Solar Magnetic Fields, IAU, 1971]

Doubted that the reversals were real...

Early MWO Observations

after Babcock Invented the Magnetograph “by doing everything right”

Strong Polar Fields

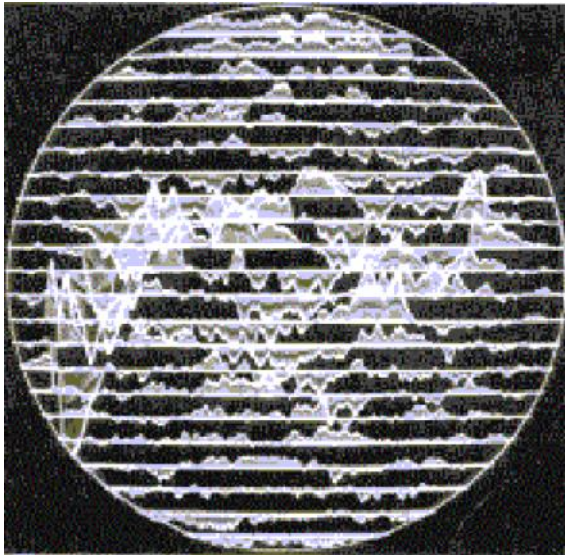

MWO Magnetogram 1953

Weak Polar Fields

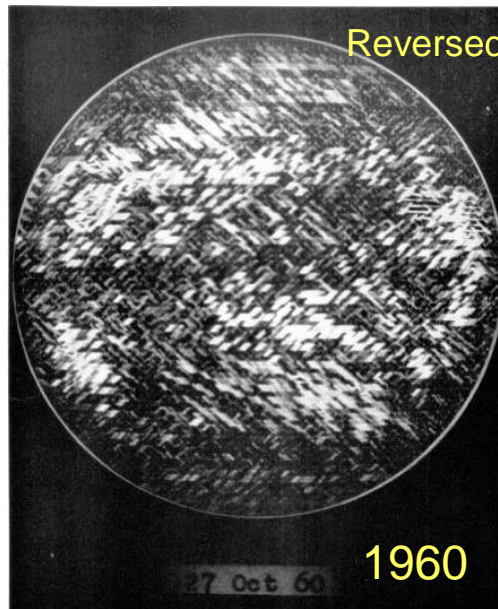

Weak Polar Fields

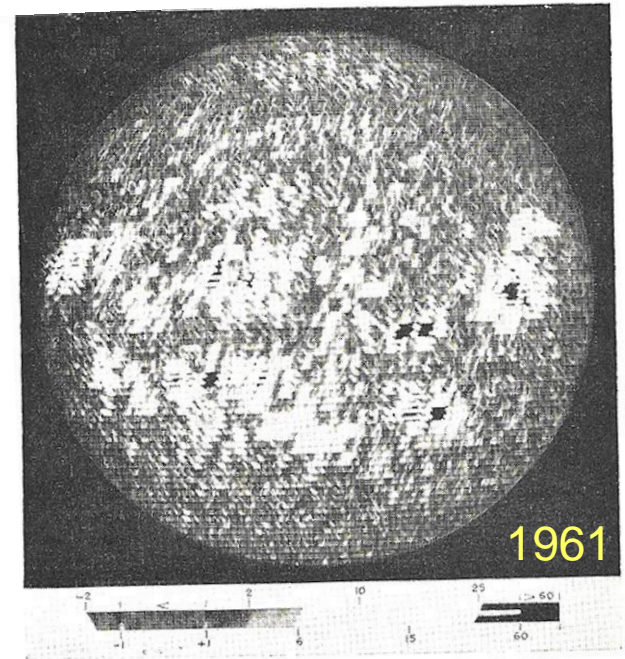
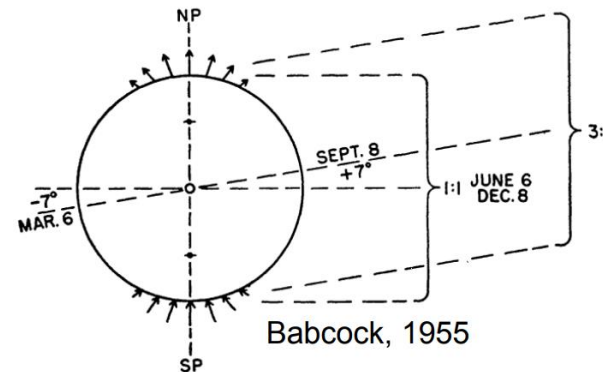
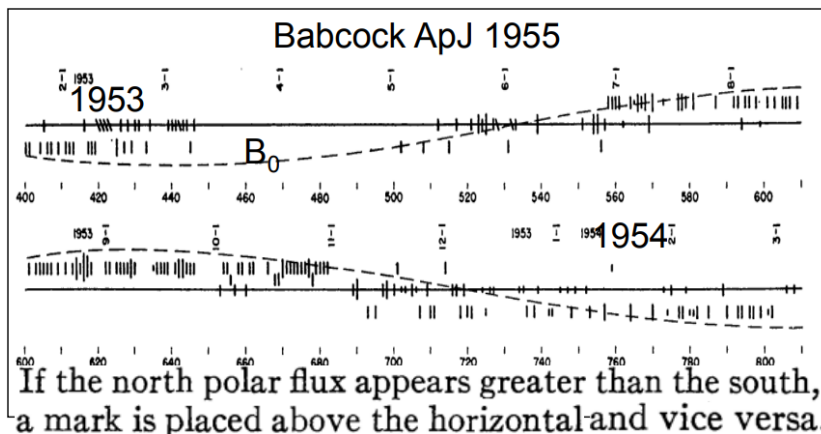
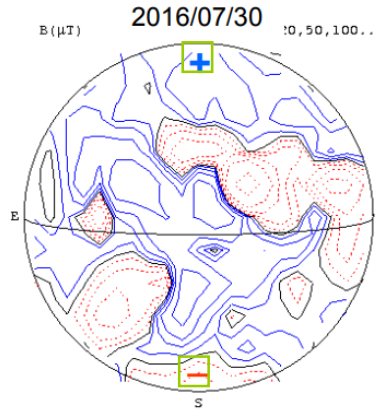
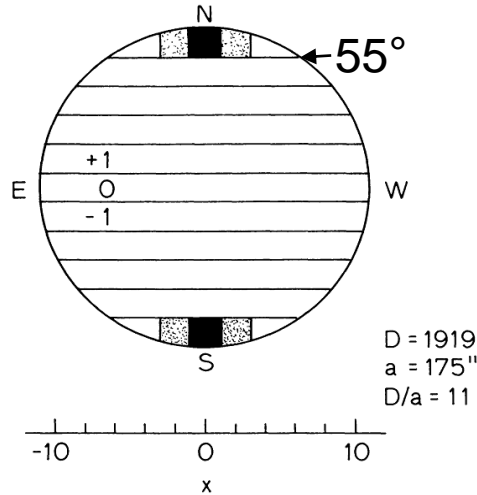
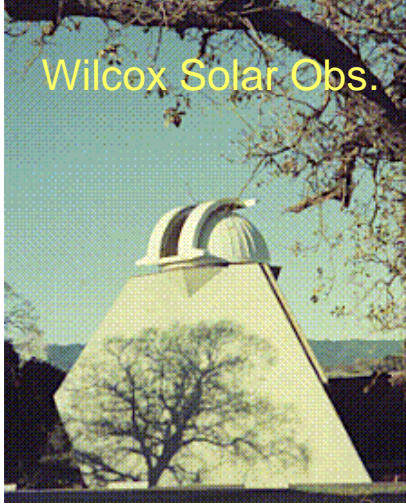

Fig. 1—The Solar Magnetogram for 21 July 1961.



Explanation of the annual variation: concentration at the poles

WSO Observations since 1976



WSO Magnetogram

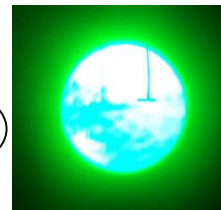
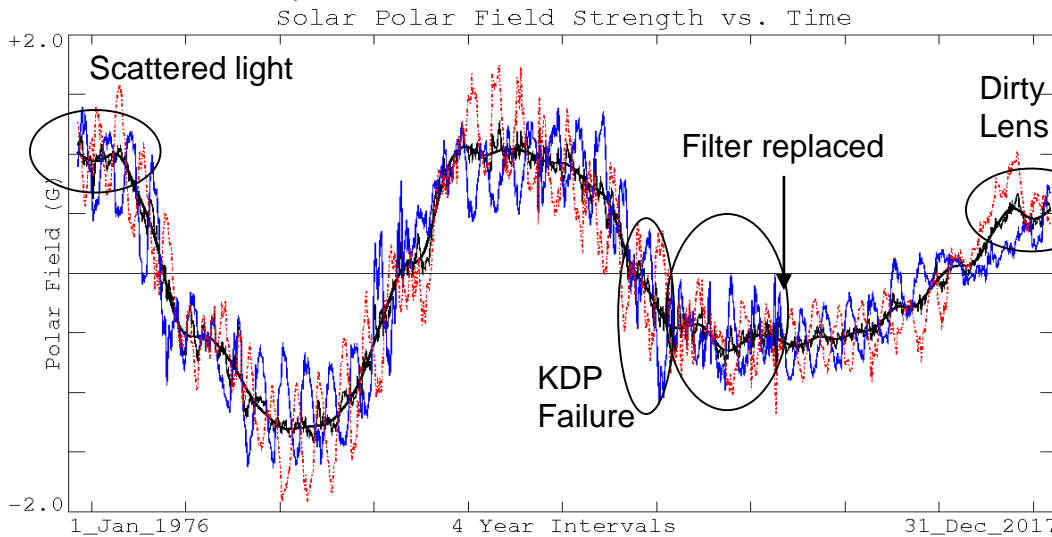
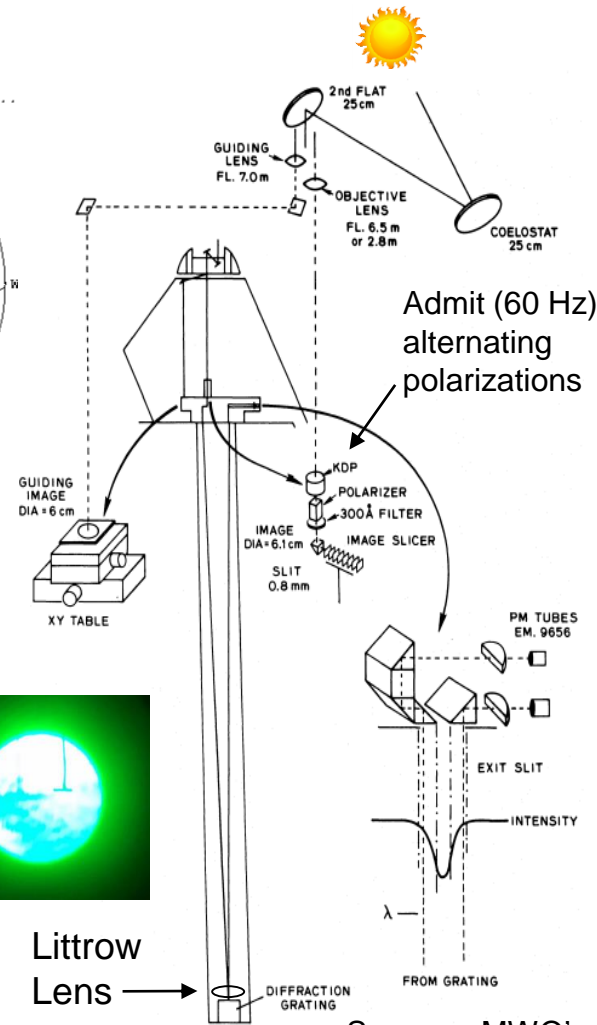

Littrow Lens

Same as MWO's

The magnetograph has never been upgraded

We found the Polar fields to be **Radial** and strongly Concentrated towards the poles

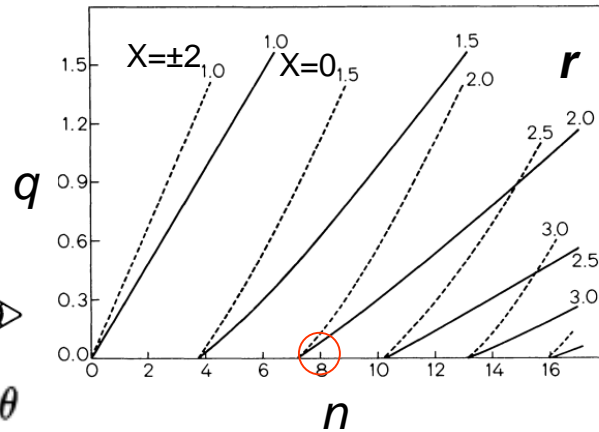
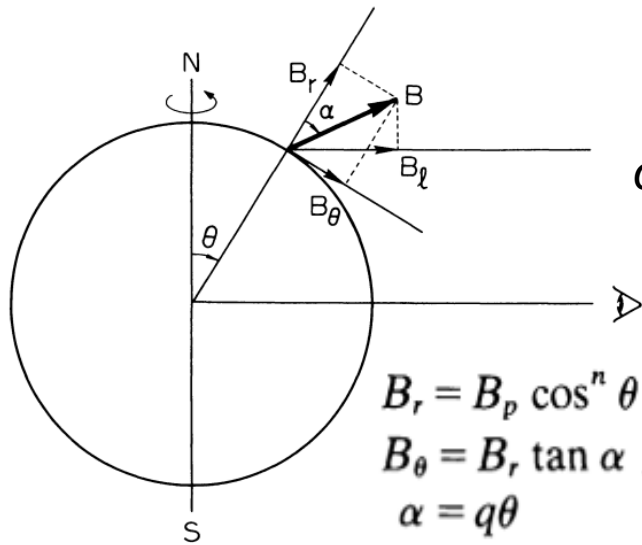

$$r = \frac{\langle B \rangle_{\text{comp[toward]}}}{\langle B \rangle_{\text{comp[away]}}} = 2.1 \pm 0.1$$

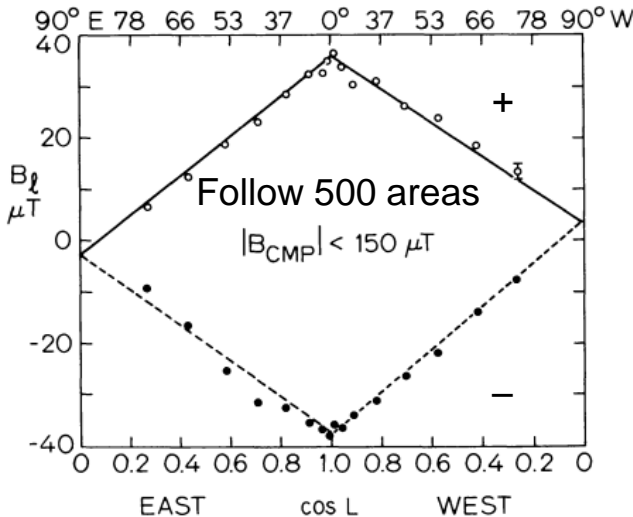
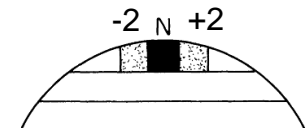
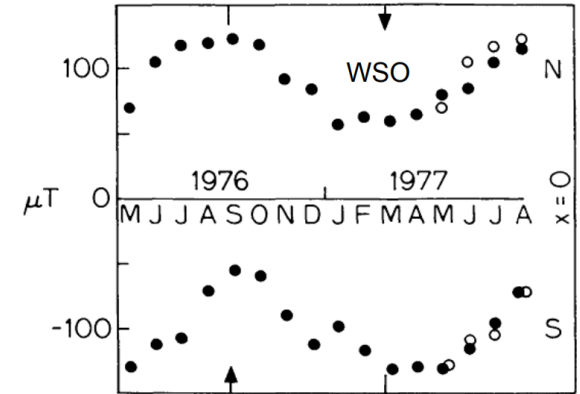

We found $n = 8 \pm 1$ and $q = 0.0 \pm 0.1$ and thus:

$$B = B_p \cos^8 \theta$$

Other researchers have confirmed this with n in the range [7-10]

Calculate the average line-of-sight component of the model field weighted by limb darkening within each of our apertures for various tilts, B_0 , of the polar axis through the year

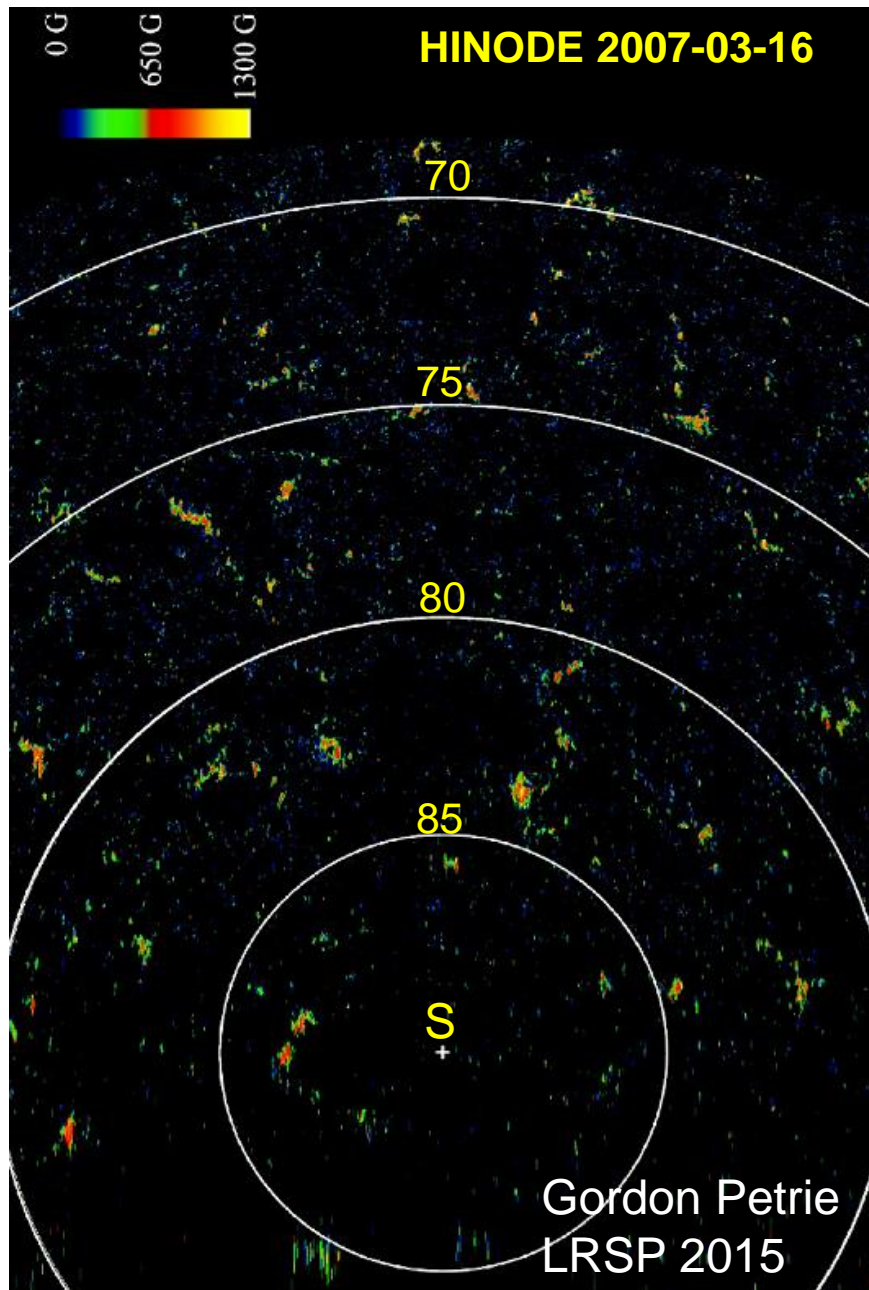

Fine Structure of kG Polar Fields

The polar magnetic 'landscape'

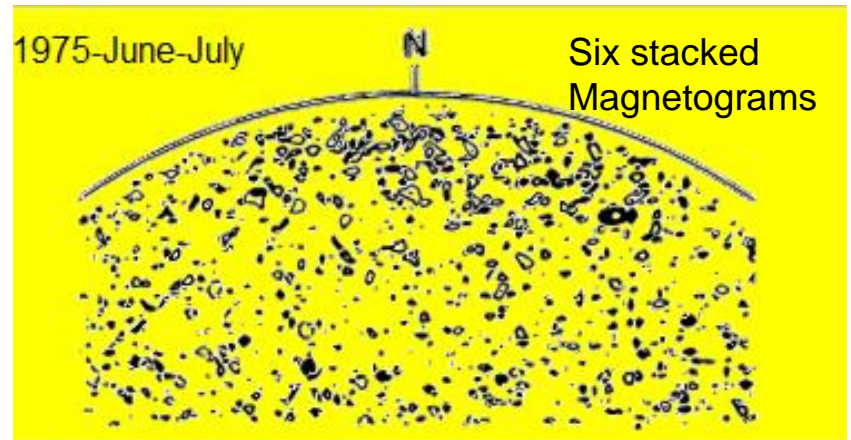

MWO: Howard, R., *Solar Physics*, 59, 243 (1978)

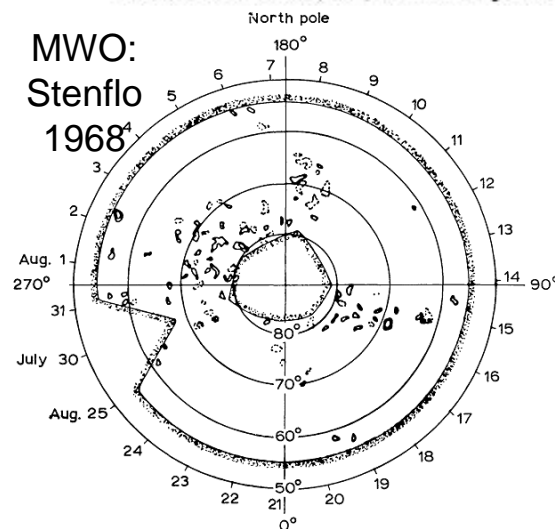

This concentration of strong flux elements near the poles has been observed for a long time; a meridional flow seems to be needed for this.

Poleward Migration of Flux

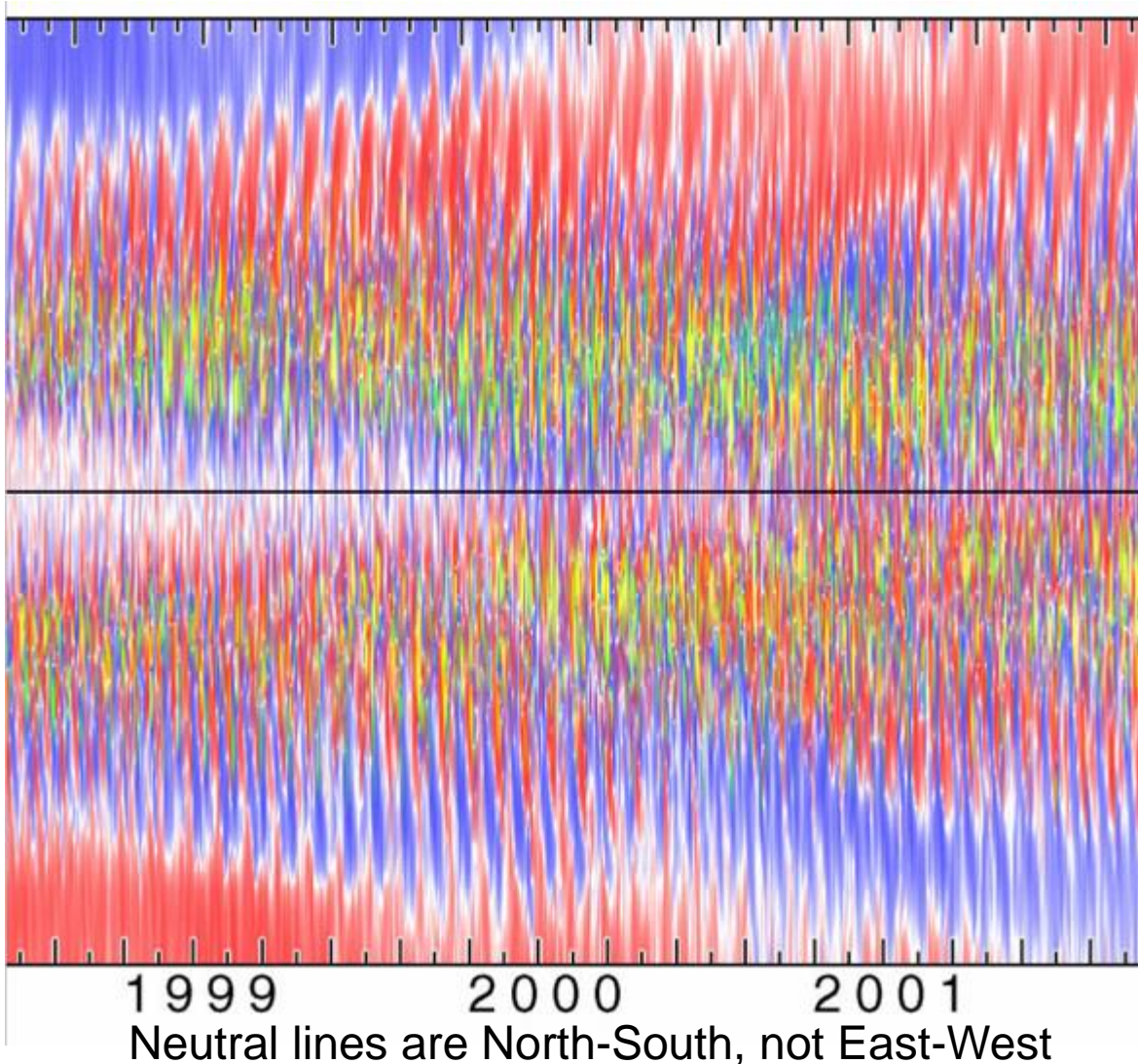

Flux of **both** polarities move towards the pole. There is no evidence for significant amount of flux crossing the equator

Zonal averaging over a rotation (as is often done) obscures the actual, real magnetic flux migration:

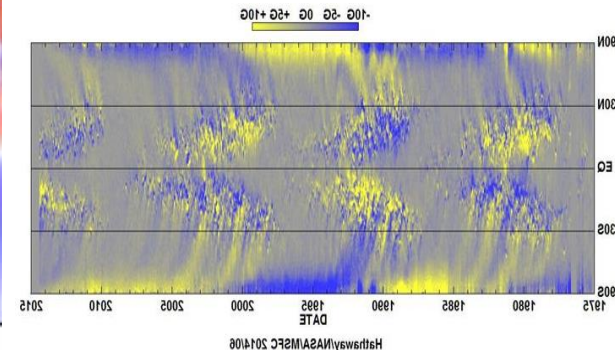

This is No News, of Course

B.1 Polar Crown Filaments and the Polar Magnetic Field, K. TOPKA and R. L. MOORE, Caltech, BBSO, and B. J. LABONTE and R. HOWARD, Mt. Wilson Obs., Carnegie Institution of Washington. We report on the results of a follow up study to the recent results of Howard and LaBonte (submitted to Solar Physics) concerning the evolution of solar photospheric magnetic fields

....

conclude that the observed behavior of polar crown filaments during the solar activity cycle supports the results of Howard and LaBonte in that the solar polar magnetic field arises from discrete injections of field from active region latitudes and that there exists in the sun a meridional flow. We further

conclude that magnetic field of both polarities must be migrating poleward, but that the following polarity dominates slightly.

HMI Super-Synoptic Map the Last Year

HMI Radial Super-Synoptic Map 2194-2207
720 sec Averages. 2017/8/16-2018/9/2

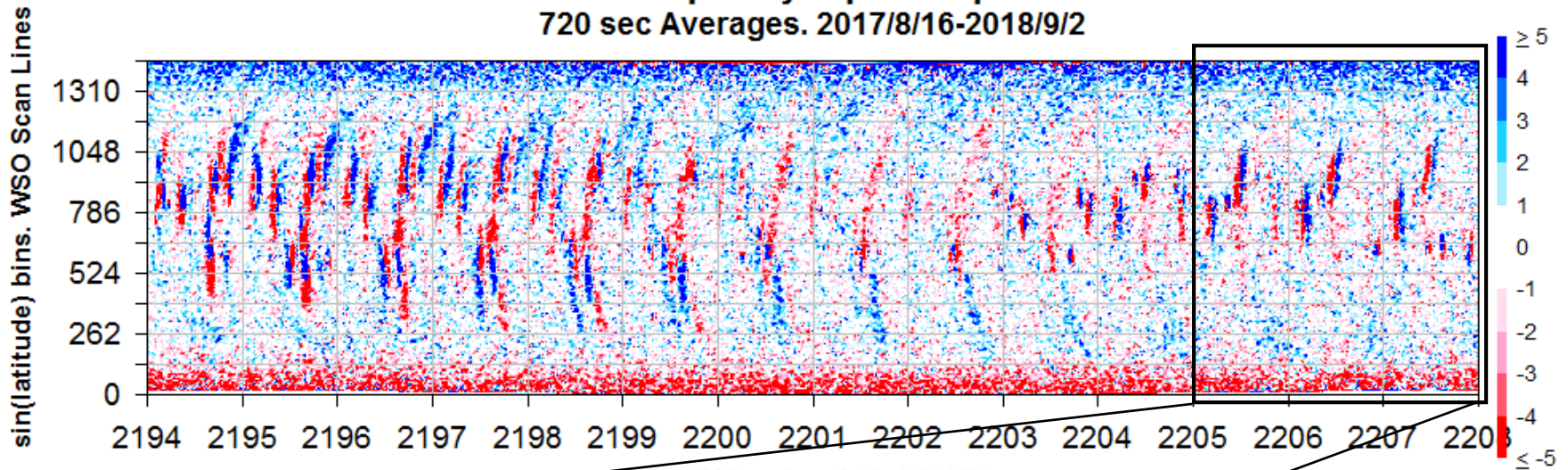

HMI Radial Super-Synoptic Map 2205-2208
720 sec Averages. 2018/6/12-2018/9/29

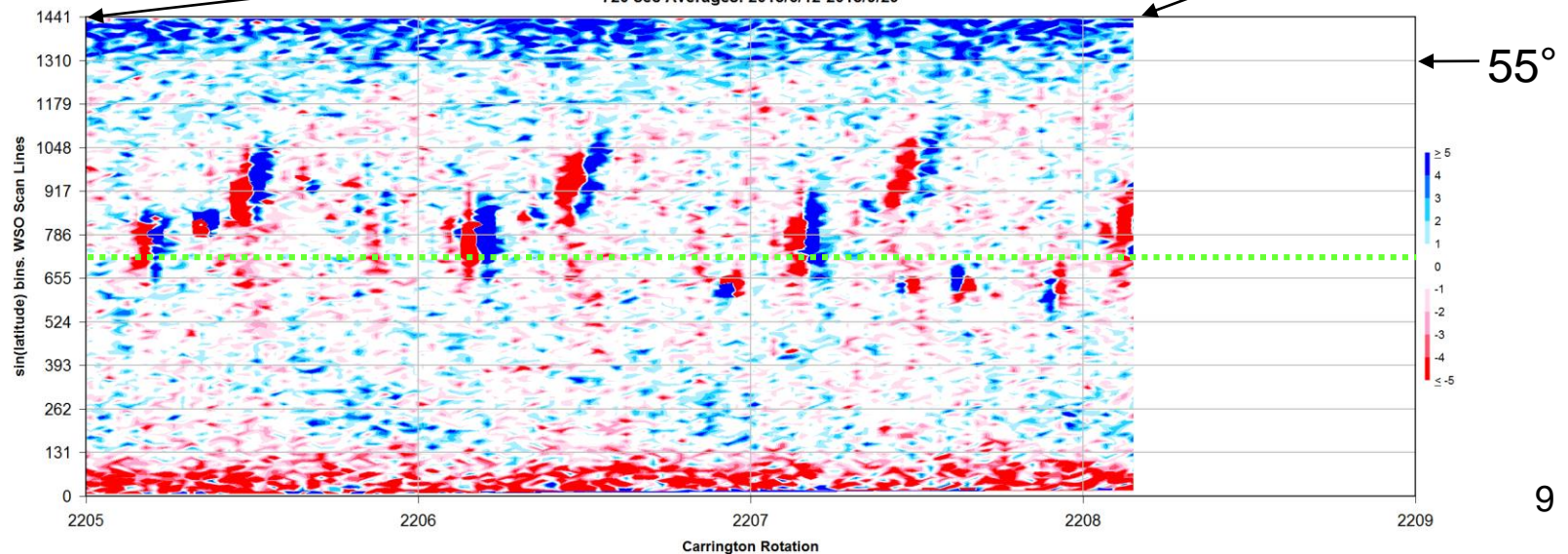

Coronal Holes are Not Polar Cap 'Extensions' but Flux on its Way to the Poles

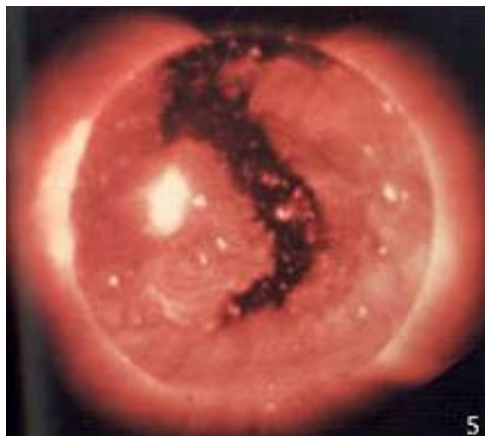
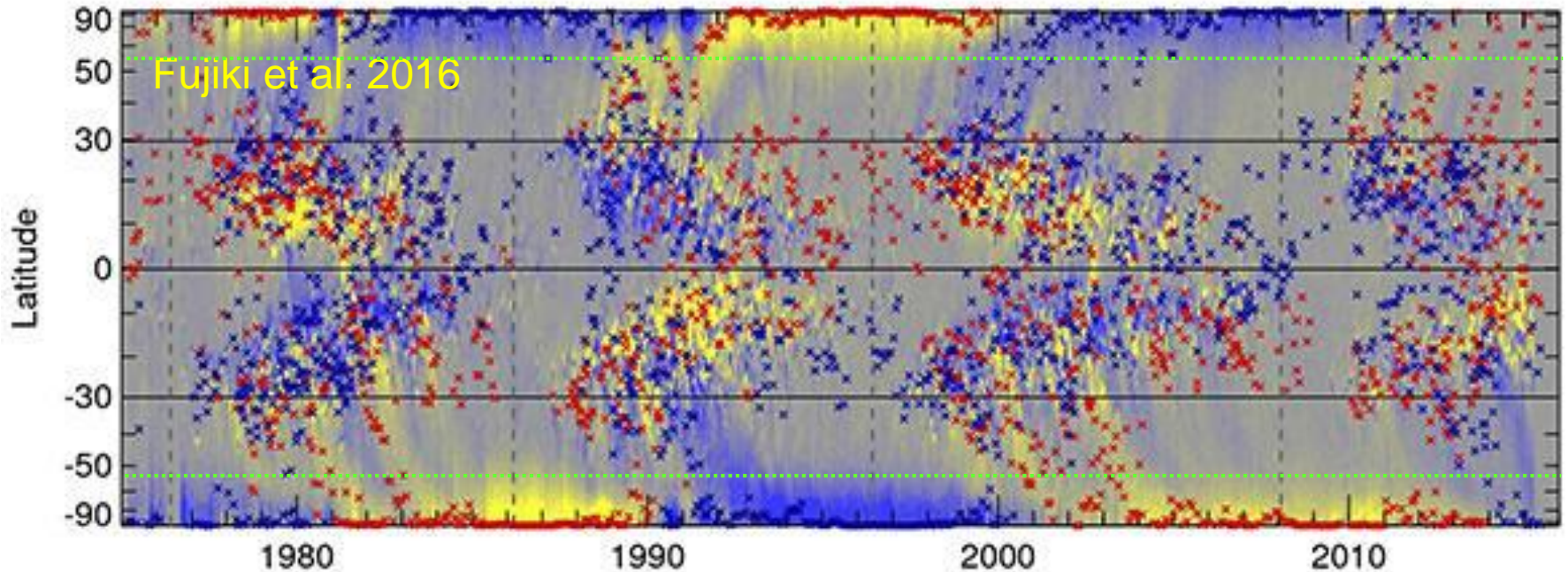

The polar caps are coronal holes and the sources of fast solar wind. A 'crown' of filaments mark the boundaries

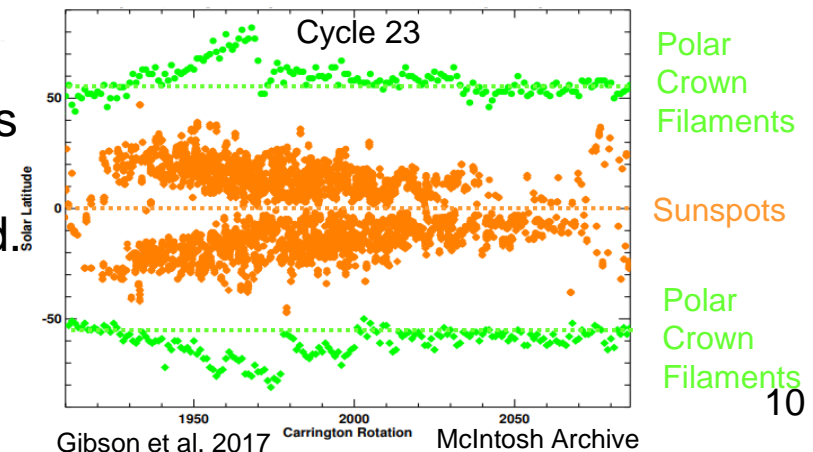

The Sun's Large-Scale Magnetic Field is *Dynamic* (Babcock 1961)

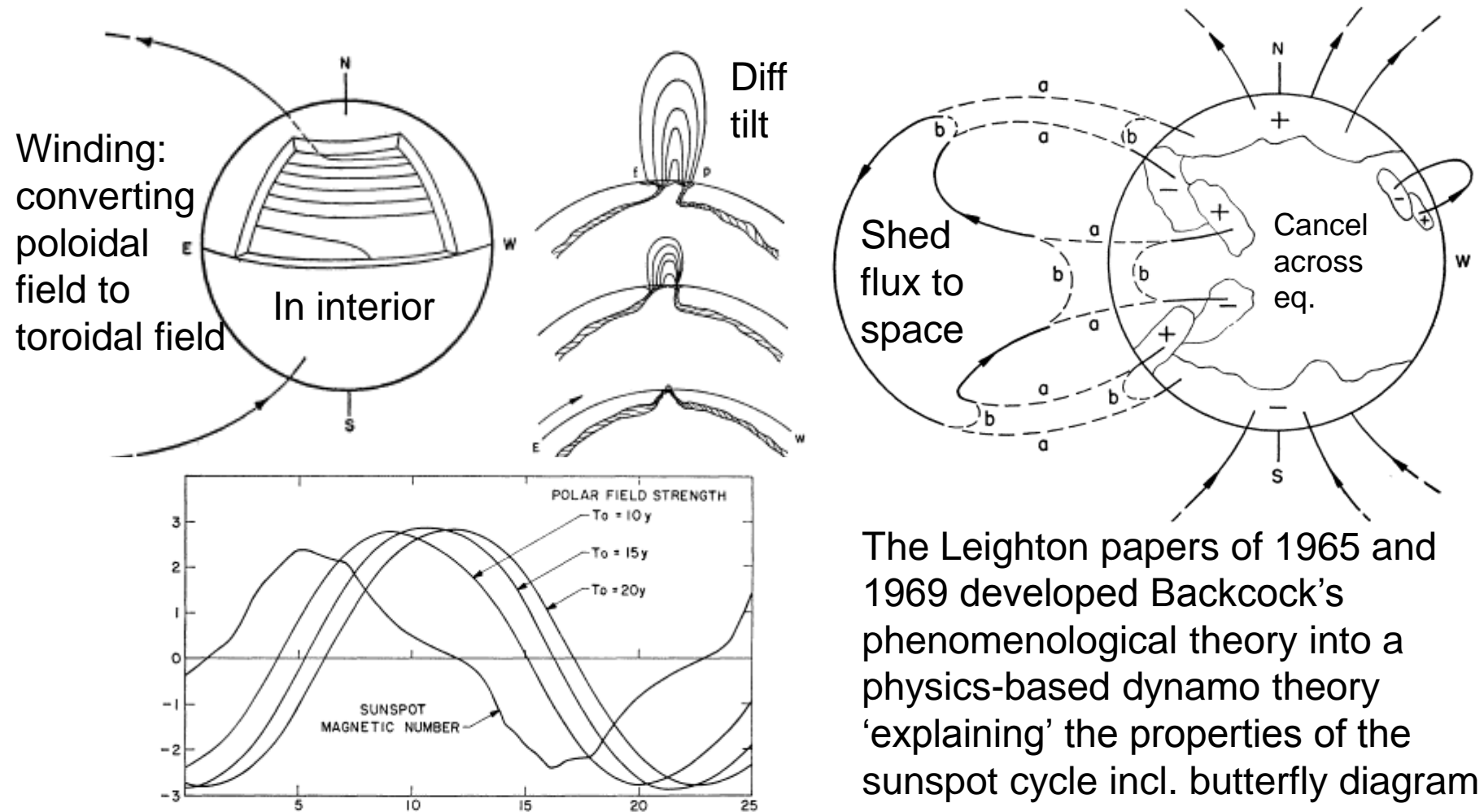
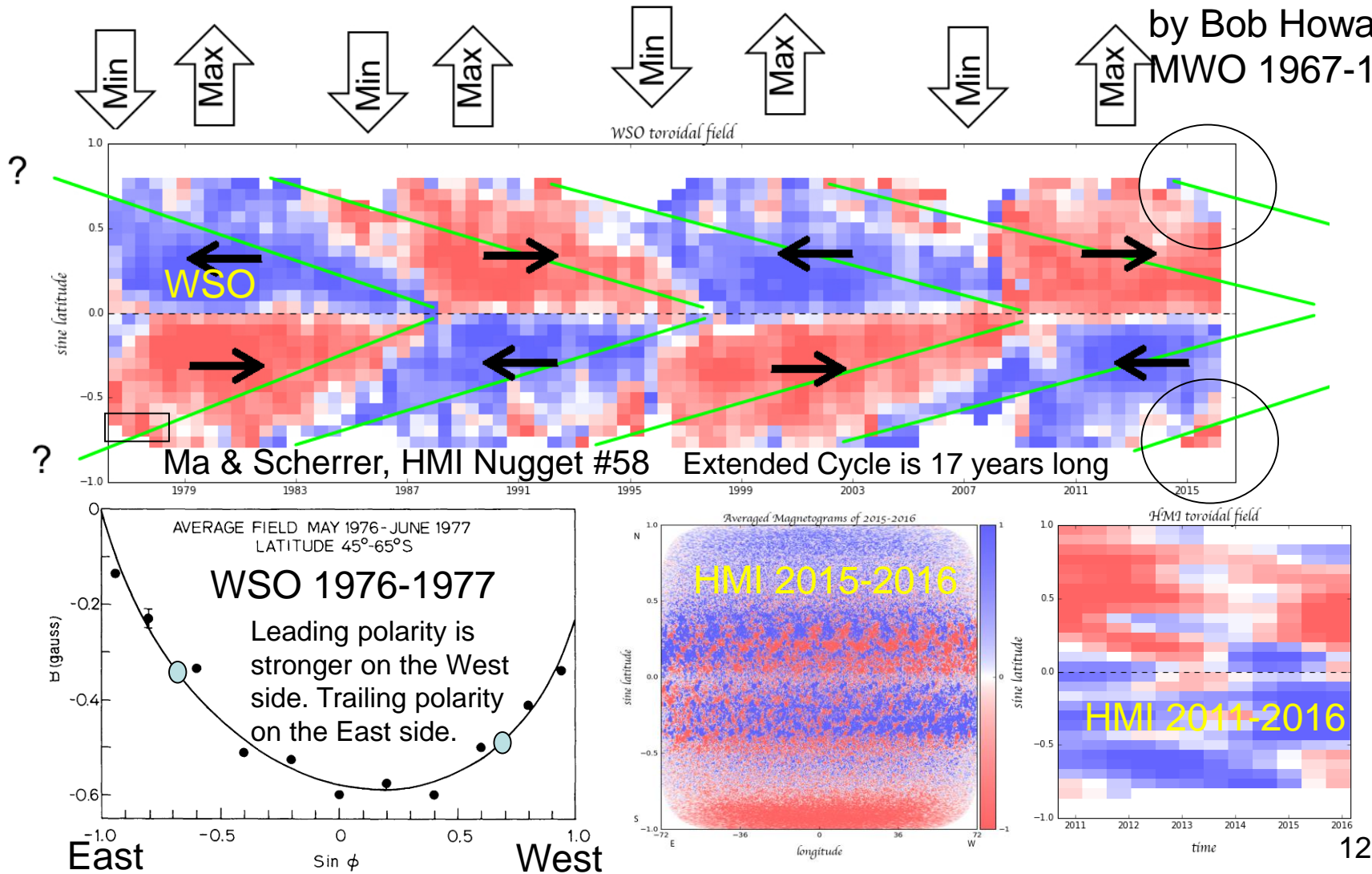

FIG. 8.—The polar magnetic field intensity as a function of time, for $T_0 = 10\text{ y}$, 15 y , and 20 y . Also shown is the total magnetic source intensity, which is roughly equivalent to the sunspot number.

The Leighton papers of 1965 and 1969 developed Babcock's phenomenological theory into a physics-based dynamo theory 'explaining' the properties of the sunspot cycle incl. butterfly diagram

Toroidal Field Shows SC25 has Begun

Effect discovered
by Bob Howard
MWO 1967-1973



THE XTENDED CYCLE

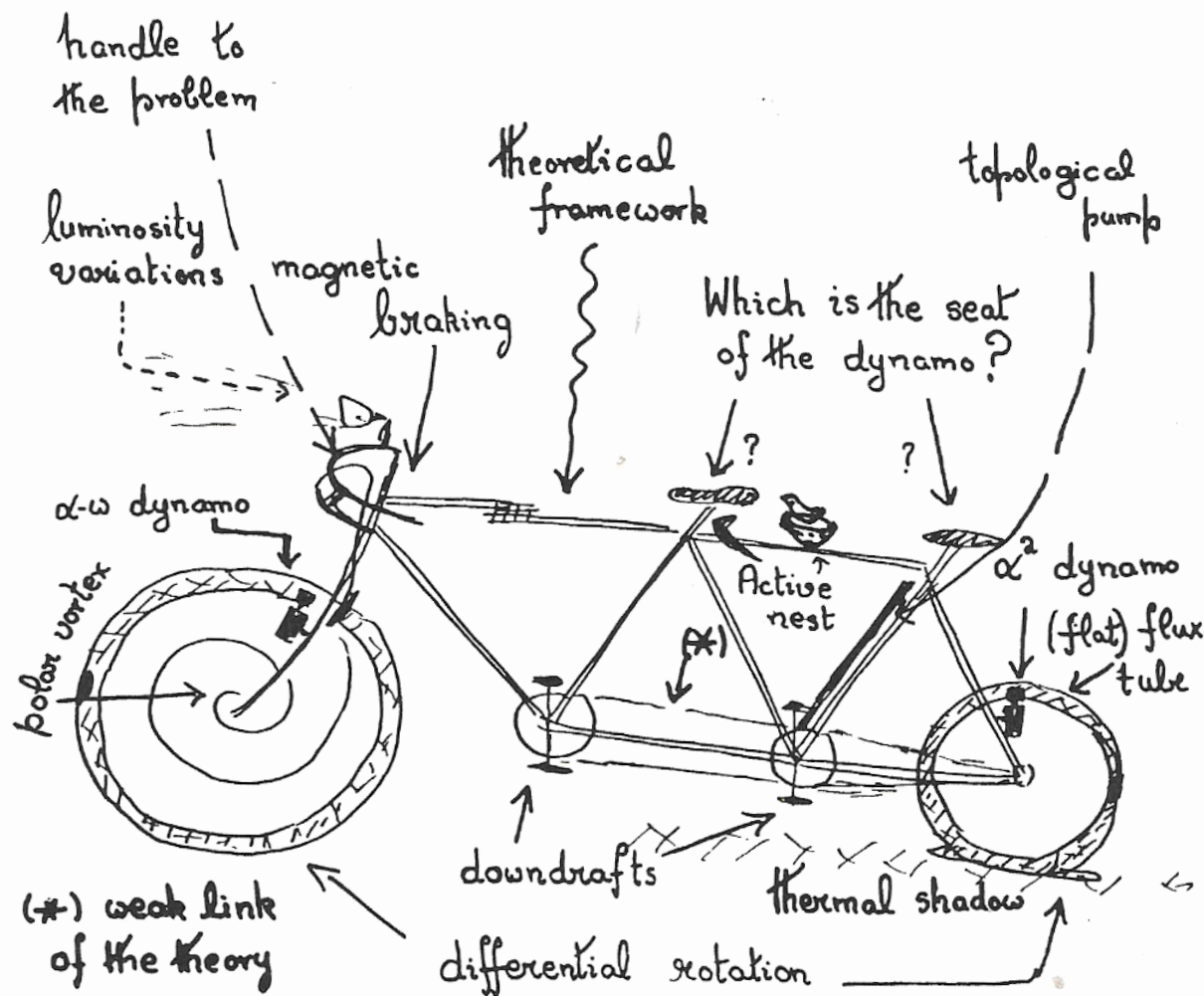

The Extended Cycle

Have we made progress in the last 27 years?

Can we even agree if there **is** an extended cycle?
Show of hands...

Fig. 8.8 A diagram of the *Xtended Cycle* constructed at a party held during the Sunspot meeting of the Solar Cycle Workshop in 1991. The author disclaims any responsibility but understands that Jean-Paul Zahn is liable for the drawing, Sydney D'Silva for the lettering, and various irreverent (and possibly inebriated) astrophysicists for the captions.

The Extended Cycle in EUV Bright Points

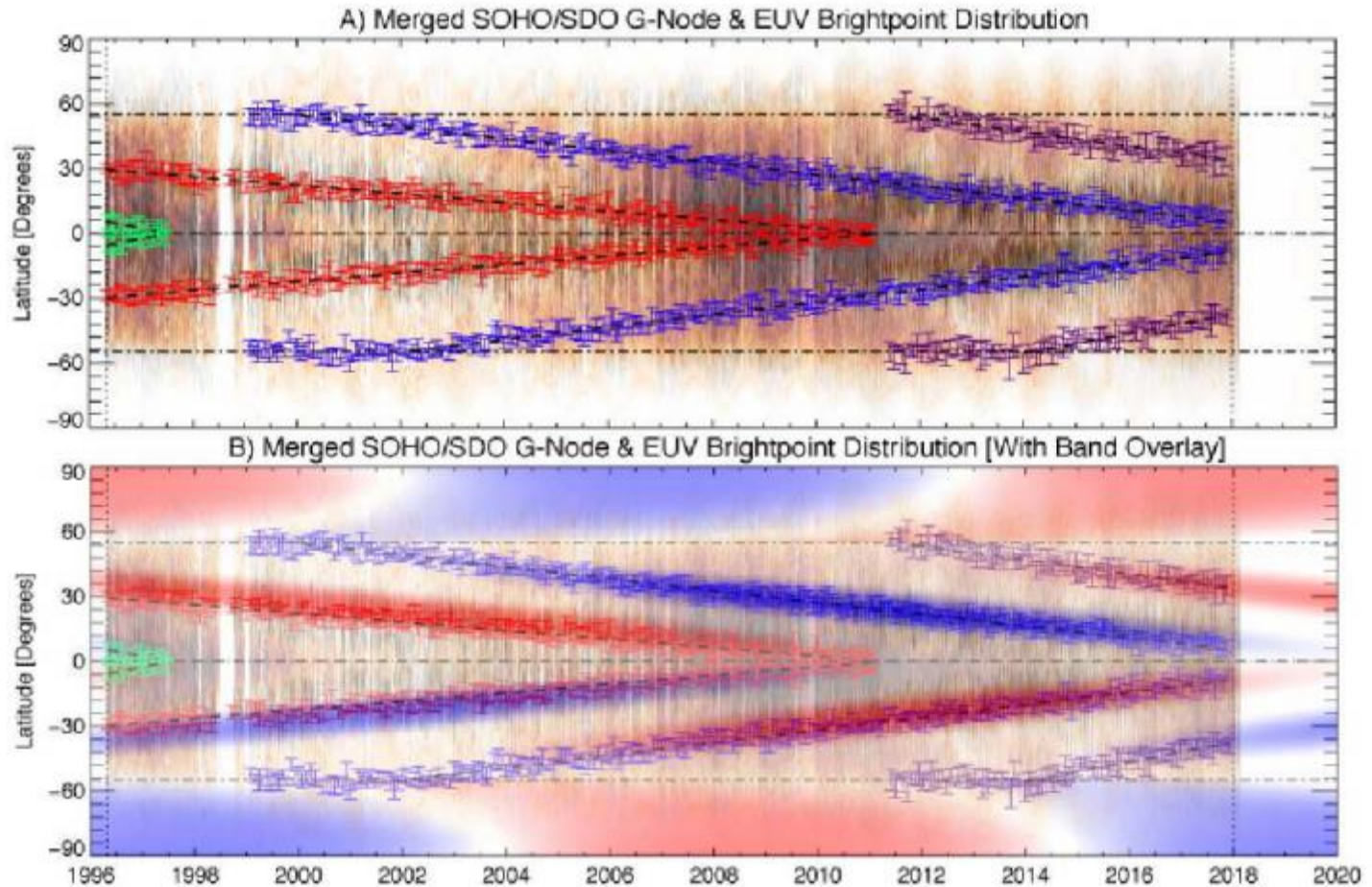

Srivastava et al. 2018

What is so special about the 55° latitude?

Extended Cycle in Torsional Oscillation

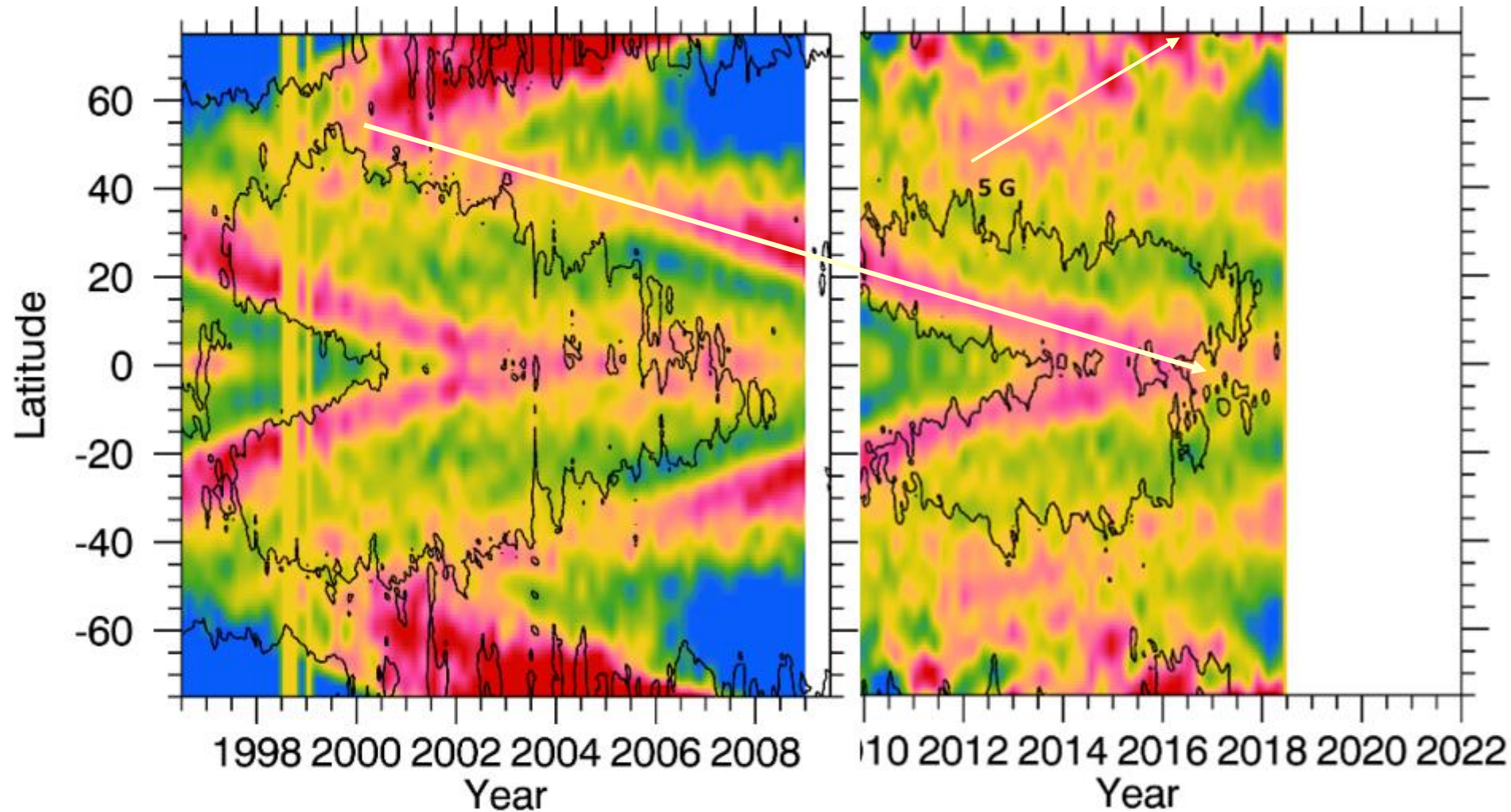

Rotation-rate residuals at $0.99R_{\odot}$ from MDI (1996-2010) and HMI (2011-present).

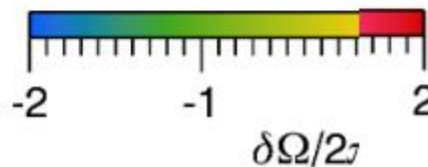

Howe 2018

Meridional Circulation Cell(s)

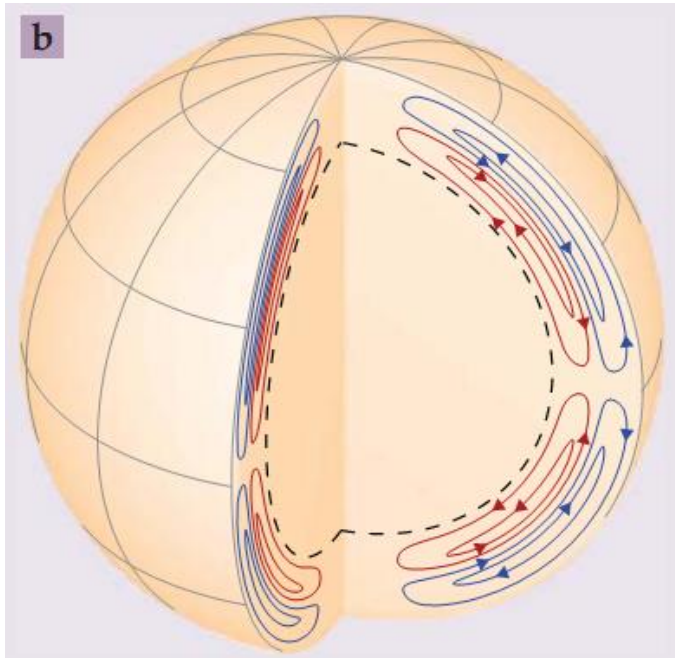

Two cells

We cannot agree on the number of cells

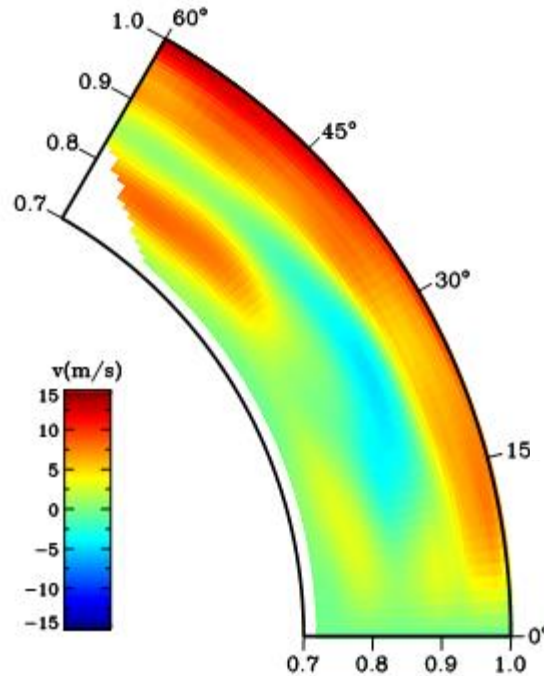

Chen & Zhao, 2017
Complicated cell structure

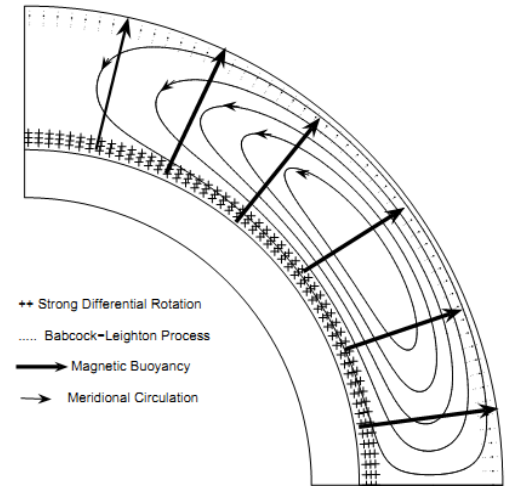

One cell
Choudhuri 2013

How does the magnetic flux get into the interior?
Advection or diffusion?

How can the meridional circulation explain the extended cycle?

Hindcasting Polar Fields in Time

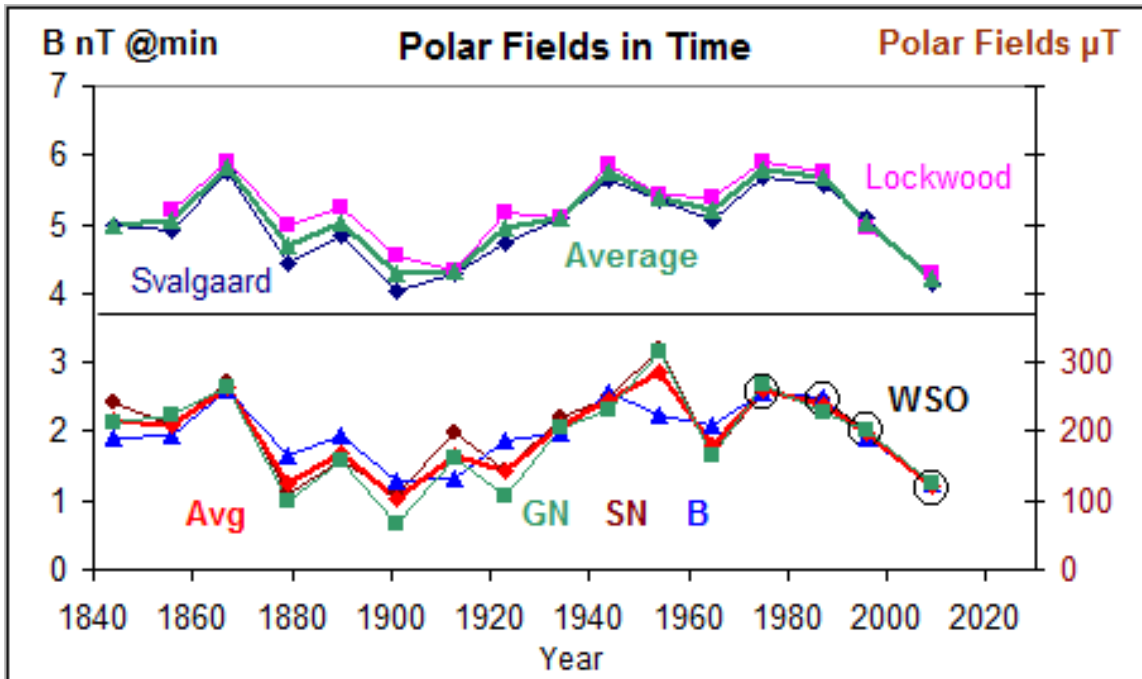
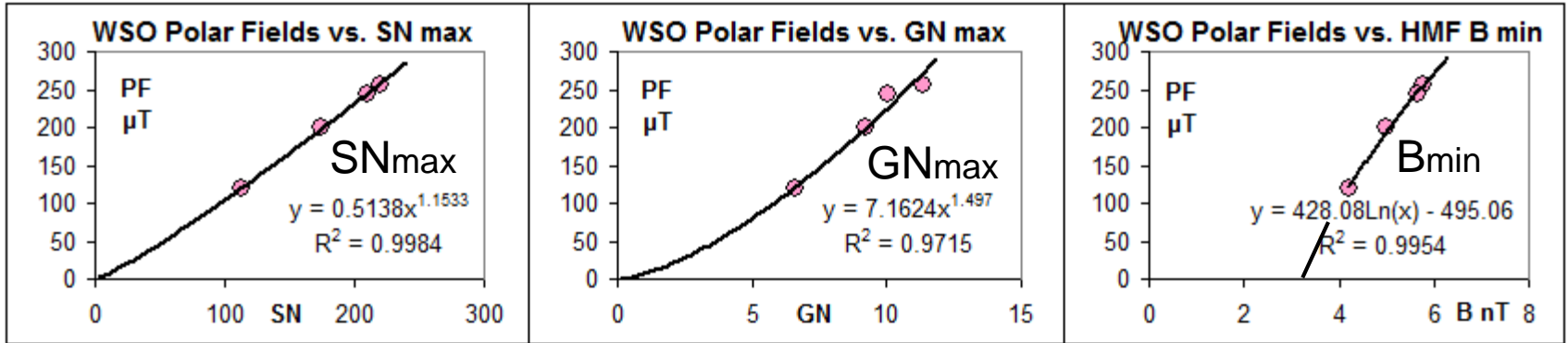

If we can forecast cycle maximum activity from the polar fields, we should be able to hindcast the polar fields from the cycle's maximum activity. If HMF B at minimum (proxy for polar fields) forecasts activity maximum, then such maxima hindcast HMF B .

Prediction of Solar Cycle 25

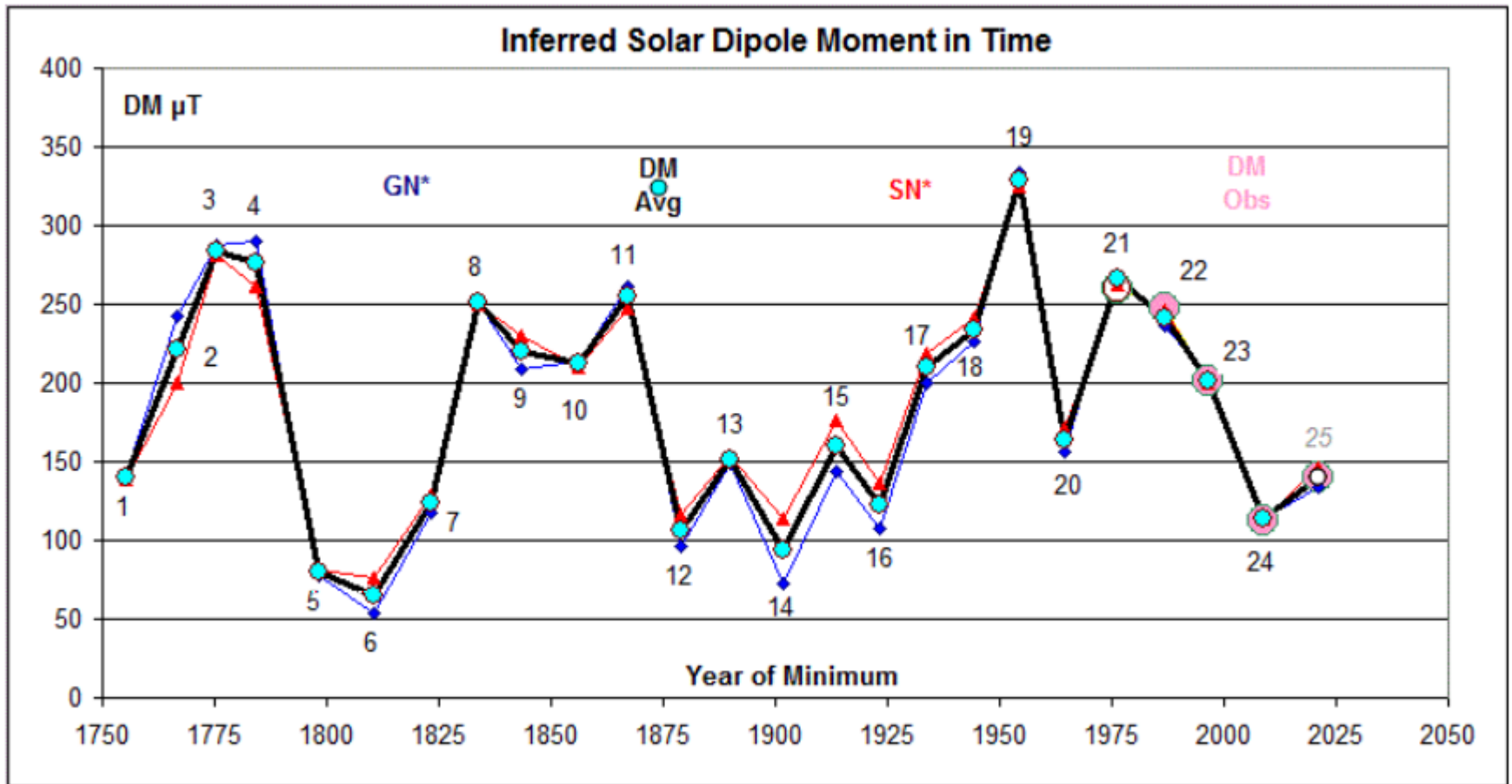

“Polar Cap Flux Key Driver of Heliospheric Magnetic Field”

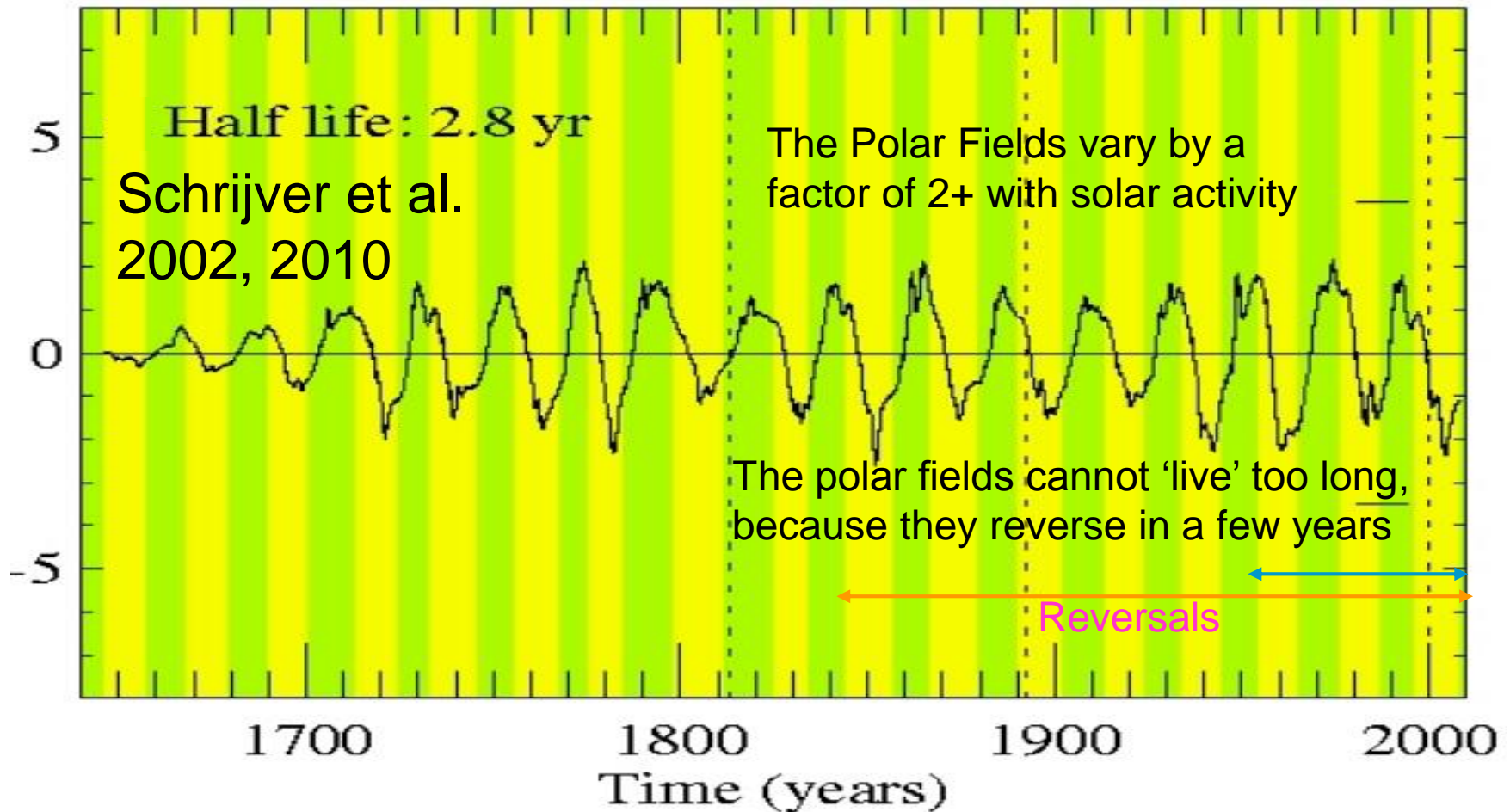

Polar Cap (above 65° North) Magnetic Flux [10^{22} Mx] for half-life of 2.8 years are just about 1% of the total measured flux that itself is probably much smaller than the real flux¹⁹

HMF derived from new Geomagnetic Indices

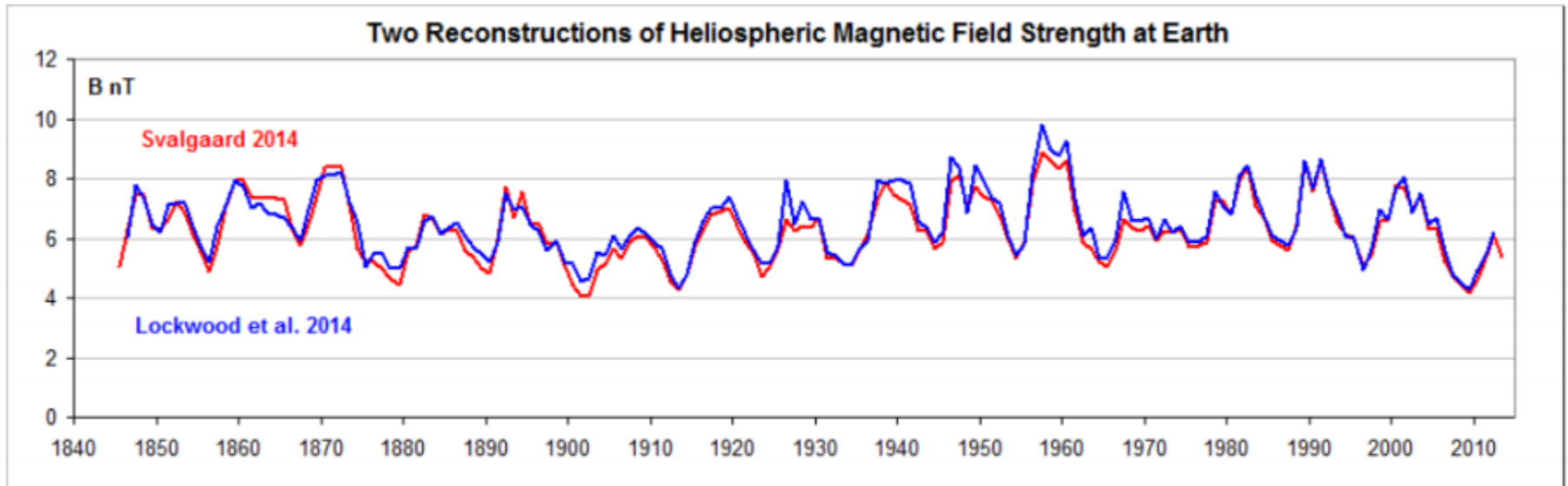
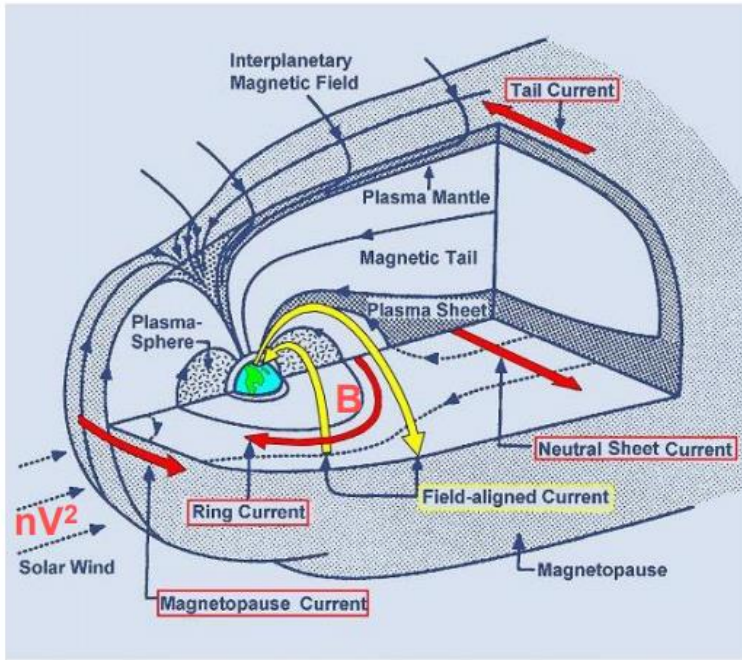

17 GHz Microwave Chromospheric Emission

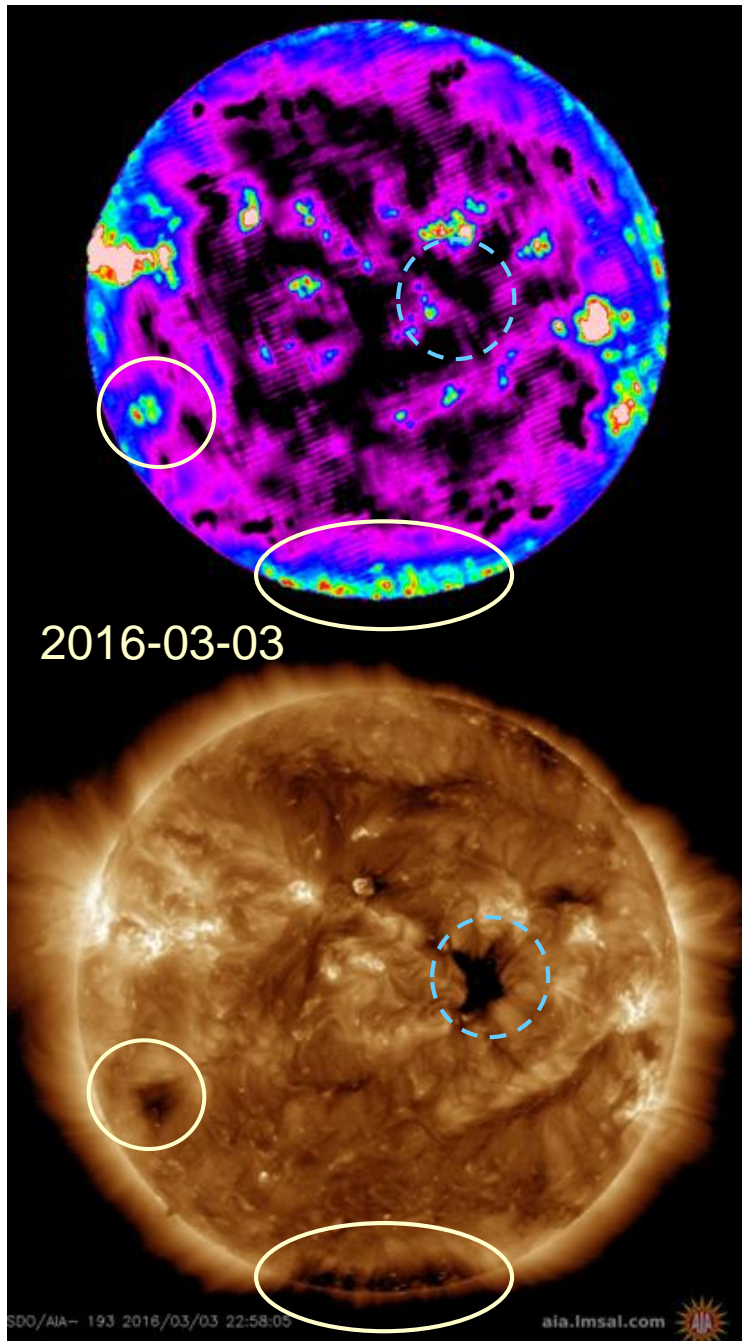

Coronal Holes at the limbs are bright in 17GHz emission mapping out magnetic field elements but are optically thin away from the limb

19961113.FTS_0

solar

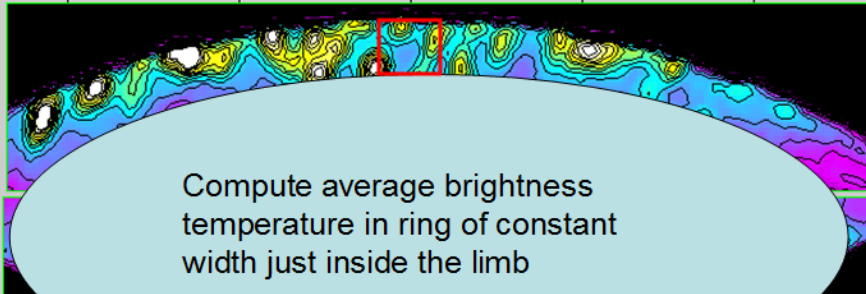

Make Synoptic Limb Chart

Nobeyama 17 GHz Synoptic Limb Chart (85")

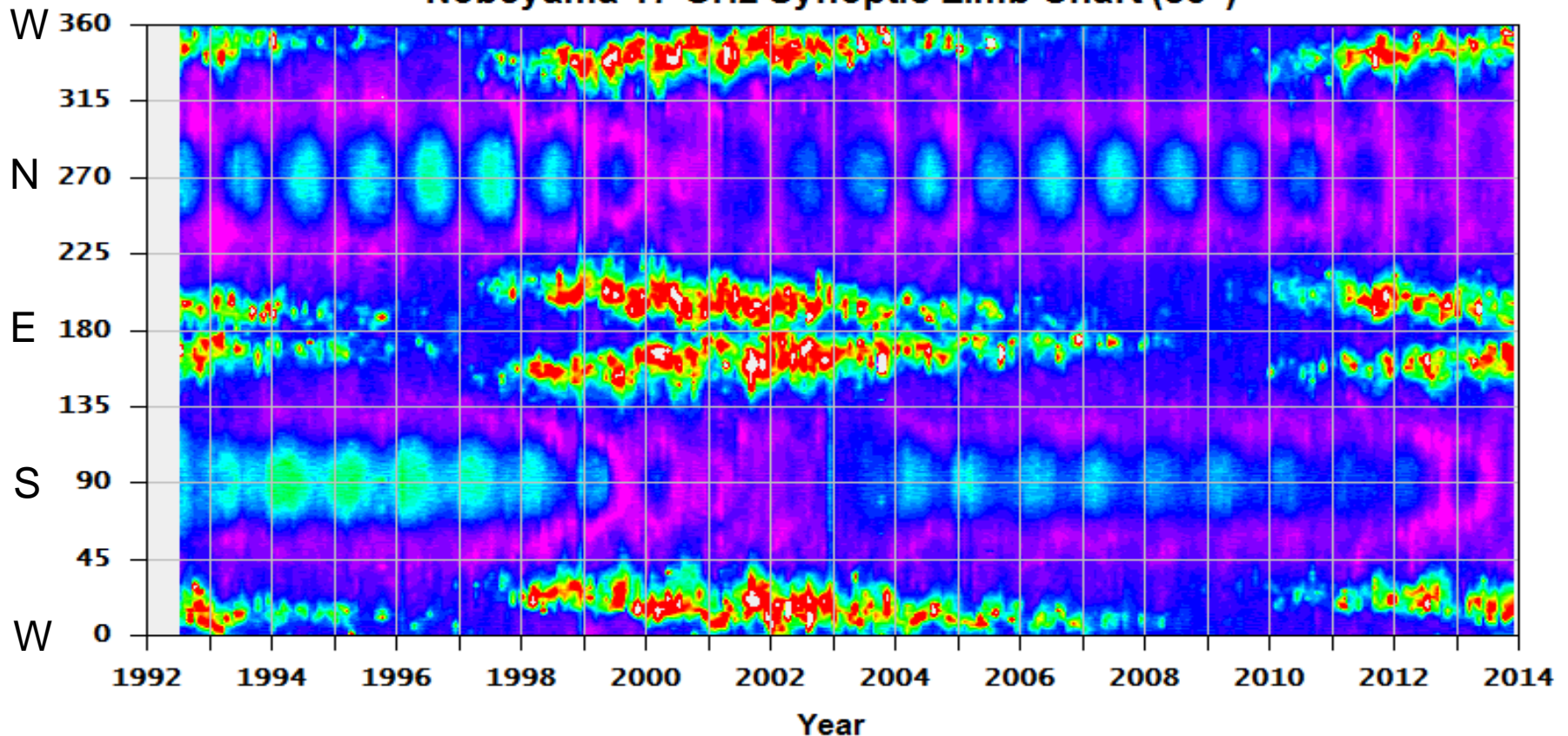

Polar Emissions wax and wane over the cycle. Note annual variation and the weaker emissions in SC23/SC24 than in SC22/SC23

Signed Excess T_B Above 10,800K Matches WSO Polar Magnetic Field

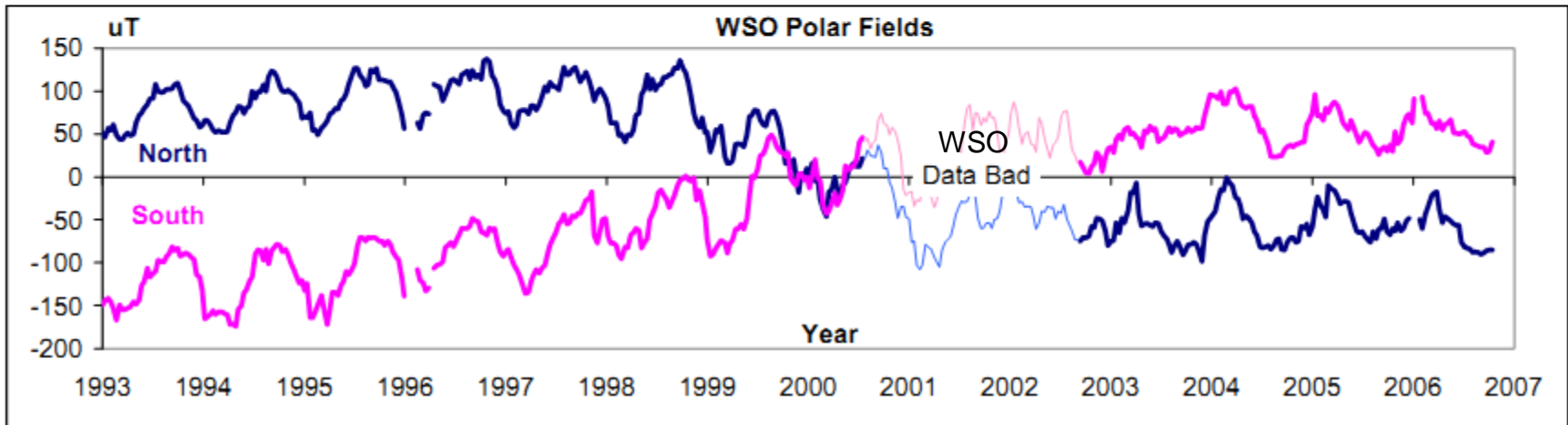
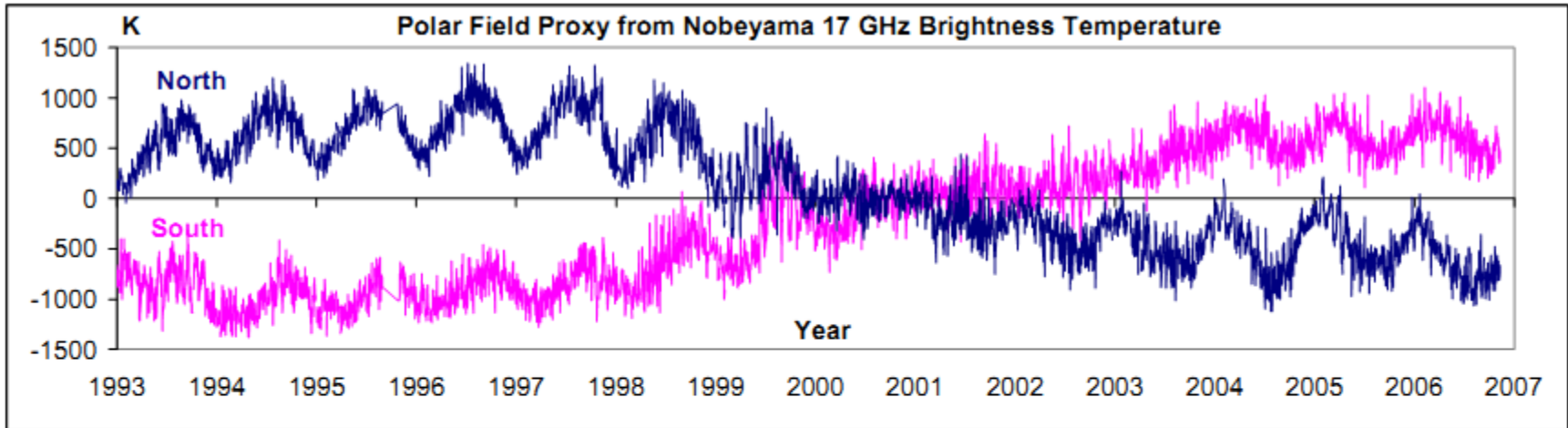

Also shows strong rotational modulation

Waldmeier's Insight (1978)

“There is a relationship between the rise time T (in years) from minimum to maximum and the maximum smoothed monthly sunspot number R_{Max} . The times of the extrema can be determined **without knowledge of the reduction (or scale) factors**. Since this relationship also holds for the years from 1750 to 1848 we can be assured that the **scale value of the relative sunspot number over the last more than 200 years has stayed constant** or has only been subject to insignificant variations”

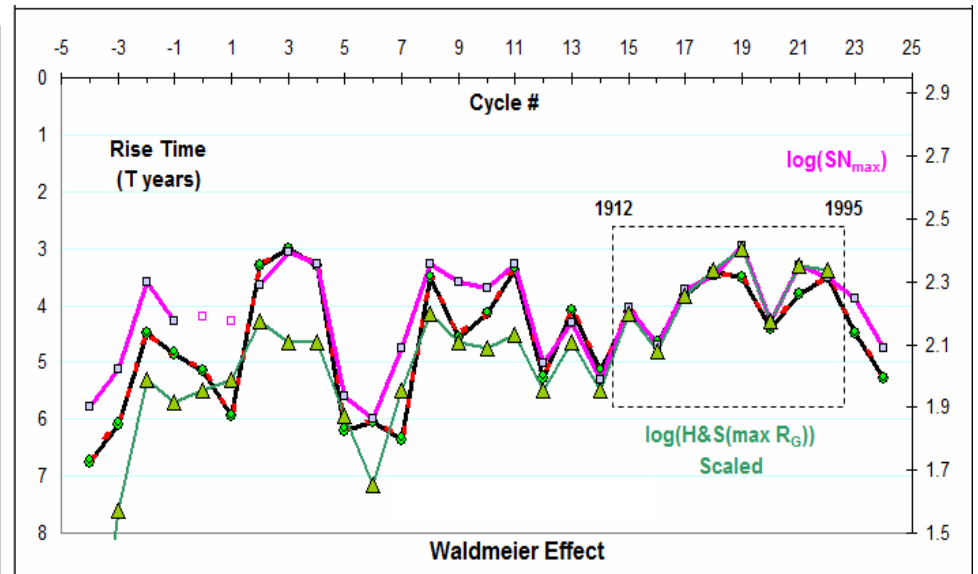
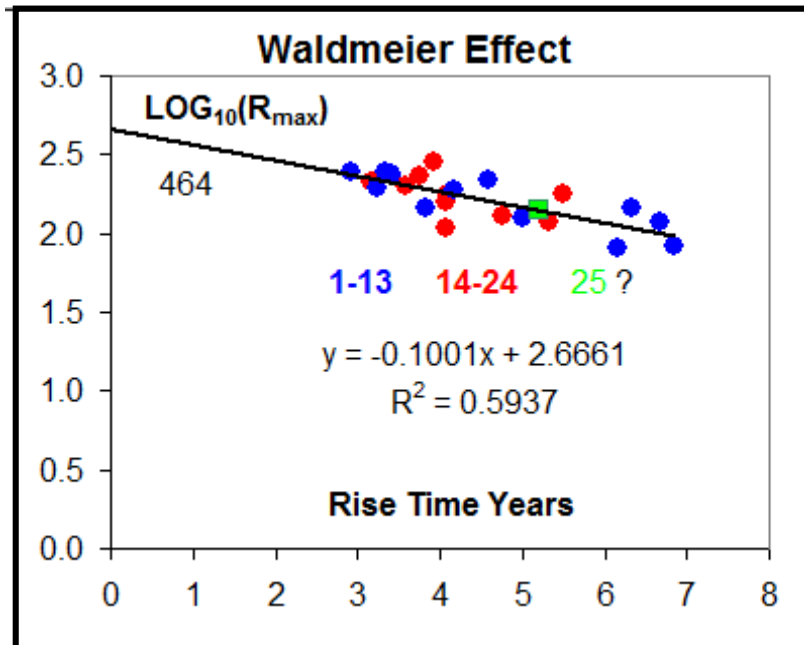

We can use the effect to get the rise time and thus when maximum will occur

"It cannot be said that much progress has been made towards the disclosure of the cause, or causes, of the sunspot cycle. Most thinkers on this difficult subject provide a quasi-explanation of the periodicity through certain assumed vicissitudes affecting internal processes. In all these theories, however, the course of transition is arbitrarily arranged to suit a period, which imposes itself as a fact peremptorily claiming admittance, while obstinately defying explanation"



Agnes M. Clerke, A Popular History of Astronomy During the Nineteenth Century, page 163, 4th edition, A. & C. Black, London, 1902.

Have we made Progress? Perhaps Some, but Maybe not Much. Cycle 25 might give us needed confidence, except we, full of hope, say that for every new cycle...

A society that travels to other planets needs forecasts of the solar activity visible from any point in the solar system several years in advance...

(Pesnell, 2016)

We need imagination, but not too much of it

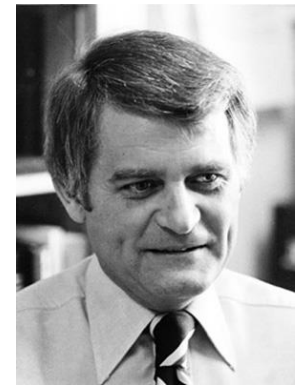

“Progress is more often made by re-examining what had been looked at, and sometimes ignored, by generations of earlier students, but with new insights and new reasons and even new prejudice. To improve the historical record we must probably rely most on what we already have at hand. *After 130 years it is probably time to repeat Wolf’s analysis of the earliest sunspot records.* The period of the Little Maunder Minimum [the Dalton], between 1800 and 1820, seems one that needs more study. The rich auroral history deserves deeper and repeated attention in the light of our rapidly-developing understanding of coronal holes, and the solar wind, and the pictures now emerging of the real nature of the earth’s magnetosphere. It is probably tied more closely to what we read in radiocarbon, since both deal with features of solar particles and fields.

What is probably needed, for both re-analysis and in the search for new historical sources, is imagination, but not too much of it.”

John A. Eddy, The historical record of solar activity, in *The Ancient Sun*, pg 119 (Geocosmica et Cosmochimica Acta, Suppl. 13, 1980)

Let Us Have a Productive Workshop

***The response of the true
Sun to the research efforts***



L. Paternò, 2009

The End

Abstract

The shape of the solar corona near minimum had already in the late 19th century led to suggestions that the sun had a General Magnetic Field. It was only in the 1950s that the Babcock father-son team succeeded in reliably measuring this field and found that it was concentrated around the poles. The observed (and unexpected) reversal of this Polar Field at solar maximum in ~1958 guided Babcock to his celebrated Solar Cycle Model in 1961 in which the polar fields at minimum serve as the seed for the generation of the magnetic sunspots in the following cycle as elaborated theoretically by Leighton in 1969. The basic ideas of this Babcock-Leighton model still today form the foundation for our description [‘understanding’] of the generation and evolution of the solar cycle, and led to the suggestion by Schatten, Scherrer, Svalgaard, & Wilcox (1978) that the magnitude of the polar fields near minimum could be used to predict the magnitude of the coming solar cycle. Observations have generally borne this suggestion out, especially the successful prediction of the now ending Cycle 24. Yet, many uncertainties and mysteries remain. The transportation of magnetic flux from the sunspot zones (the ‘toroidal’ flux) to the Polar Regions seems to be due to a meridional circulation that itself is poorly understood (how many cells? to what depth? etc.). How does the flux get into the deep interior? (advection and/or diffusion?). Can we model this process and from the observed or guessed distribution of active regions predict the polar fields and thus in turn the next cycle? How can the polar fields (and that in coronal holes generally) ‘live’ for years? Are there other processes that could maintain [or contribute to] the polar fields? Do the fields always reverse near solar maximum? even if solar activity is confined to one hemisphere only (as perhaps during the Maunder Minimum)? How do the polar fields extend into and help shape the heliospheric magnetic field? Can we reconstruct the polar fields in the past? These, and other, questions call for observations from better vantage points than the ecliptic. Understanding the polar fields seems to be key to unraveling the mystery of the solar cycle and the dynamo that drives it.